

The Core Family

Welcome to the Core line of fixtures. You will find a rich diversity of technical and aesthetic options with over 14 finishes including custom wood trims, flux and source selections featuring 90+ CRI fixed white and our world class Ambient Dim (Warm Dim), a 3.7:1 uniformity ratio from top to bottom of the wall and plethora of driver and control choices. The Core wall wash is created on a platform allowing a high degree of modification, so if you don't see what you are looking for, just ask.

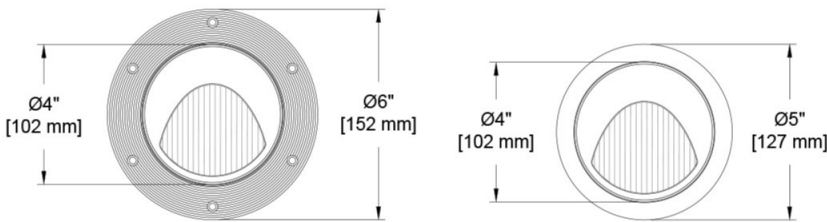
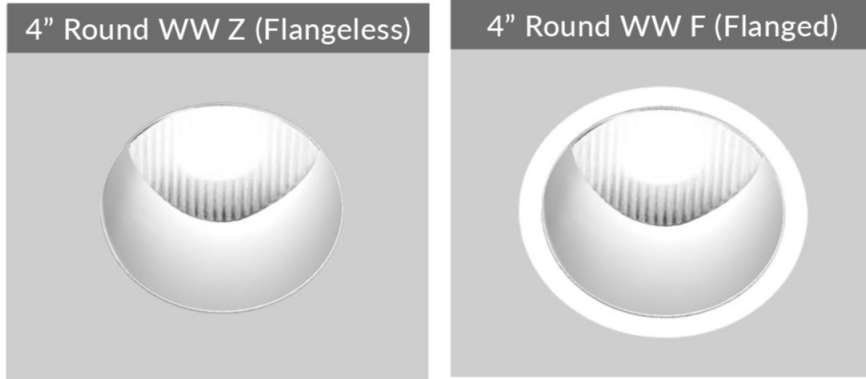

Wood Trim Available

PROJECT:

TYPE:

SPECIFIER:

DATE:

Key Points (CR4WW-RF)

Trim

- Flange or Flangeless
- Frosted Supertex borosilicate glass spread lens, hinged for source and driver service
- Flangeless includes plaster flange
- 14 color options + custom RAL or wood available
- One-piece die cast aluminum or machined wood trim

Source / Optics

- Lifetime: L87B3 >55,000 hours at 40°C ambient
- 2400K, 2700K, 3000K, 3500K, 4000K Ambient Dim, RGBW & Tunable White options
- 90 CRI, 60+ R9 Standard- 95 CRI 90+R9 Optional
- <2 MacAdam Steps (<2SDCM) for fixed white
- Up to 1616 delivered lumens
- Uniform light from floor to ceiling. Achieves a 3.7:1 ratio on a 10' ceiling at 2.5' setback with a 1:1 on center spacing

Housing

- Compliant to with Airtight Housing (C14 source only)
- Listed – Damp or wet with shower trim
- Approved for 8 (4-in / 4-out) #12 AWG conductors rated for 90°C through wiring
- IC Rated / Airtight Housing approved for use in direct contact with insulation – Chicago Plenum Available
- Heavy gauge aluminum for new construction or remodel

Driver

- TruPhase™, 0-10, DALI-2, DMX, Ecosystem or Wireless Control
- Flicker free to IEEE 1789-2015 available with EldoLED and TruPhase™ selections
- Prewired and integral to housing
- Universal 120-277v

Ordering Codes

PROJECT:

SPECIFIER:

DATE:

TYPE:

QUANTITY:

Ordering Code Example: CR4WW-RF-F-AU-C20-35-E2-P16-CP

FIXTURE	TRIM	MOUNTING	SOURCE / WATTS	CCT	DRIVER / CONTROL	TRIM FINISH	ACCESSORIES
<p>CR4WW-RF</p> <p>Core 4" Round Fixed Wall Wash</p>	<p>Flangeless Trims</p> <p>Z Flangeless Trim</p> <p>ZS Flangeless Shower Trim*</p> <p>(for mounting choose from Flangeless Housings)</p> <p>Flanged Trims</p> <p>F Flanged Trim</p> <p>FS Flanged Shower Trim*</p> <p>(for mounting choose from Flanged Housings)</p> <p>* Aperture Lens Required</p>	<p>Flangeless Housings</p> <p>APM ●● Airtight Panel Mount IC-Rated</p> <p>P Plaster</p> <p>AP ●● Airtight Plaster IC-Rated</p> <p>PM Panel Mount</p> <p>Flanged Housings</p> <p>U Universal - Non IC Housing</p> <p>ASU * ●● Airtight Shallow Universal IC-Rated</p> <p>AU ●● Airtight Universal IC-Rated</p> <p>Shallow Housing</p> <p>ASPM ●● Airtight Shallow Panel IC-Rated</p> <p>ASU ●● Airtight Shallow Universal IC-Rated</p> <p>ASP ●● Airtight Shallow Plaster IC-Rated</p> <p>●● Supports CA Title 24 Compliance</p>	<p>Citizen</p> <p>C14 ●● 14W 833Lm 90+CRI, 60+R9</p> <p>C20 20W 1056Lm 90+CRI, 60+R9</p> <p>C28 31W 1616Lm 90+CRI, 60+R9</p> <p>C32 ●● 35W 2751Lm 90+CRI, 60+R9</p> <p>Tunable</p> <p>T9 90+CRI, 60+R9 Tunable White</p> <p>T15 90+CRI, 60+R9 Tunable White</p> <p>T20 90+CRI, 60+R9 Tunable White</p> <p>RGBW 90+CRI, 60+R9</p> <p>Ambient Dim™</p> <p>A14 ●● 15W 578Lm 95+CRI, 90+R9</p> <p>A20 ●● 21W 858Lm 95+CRI, 90+R9</p> <p>●● Supports CA Title 24 Compliance</p> <p>~See Photometrics chart for latest performance data</p>	<p>24 2400K</p> <p>27 2700K</p> <p>30 3000K</p> <p>35 3500K</p> <p>40 4000K</p> <p>Tunable</p> <p>TW1840 1800-4000K Tunable White w/ E1, E2, E3, E4</p> <p>TW2765 2700-6500K Tunable White w/ E1, E2, E3, E4</p> <p>RG1280 1200-8000K RGBW Dynamic Color Changing *Requires E2 or E4</p> <p>Ambient Dim™</p> <p>2722 2700-2200K * A14 Only</p> <p>3019 3000-1900K</p> <p>3022 3000-2200K * A14 Only</p>	<p>C1 0-10 1.0%, UNV (120-277V) linear</p> <p>C2 ELV/Triac 1.0%, (120V) linear</p> <p>E1 0-10 0.1%, UNV (120-277V) log</p> <p>E2 DALI-2 0.1%, UNV (120-277V) log</p> <p>E3 0-10 0.1%, UNV (120-277V) linear</p> <p>E4^ DMX 0.1%, UNV (120-277V) Universal DMX Driver/Controller RGBW-DMX ^ INCLUDES DMX/RDM COMPATIBLE DRIVER WITH BUILT-IN DECODER - CONTROLLER BY OTHERS</p> <p>TR2 TruPhase™ 0.1%, (120-120V) log Up to 20W Forward and Reverse compatible Phase Dimming Static White & Ambient Dim only</p> <p>LD Digital Ecosystem 1.0%, UNV (120-277V) ECO Hi-Lume SoftOn/Fade-to-Black LDE1</p>	<p>W White Paint</p> <p>B Black Paint</p> <p>D Wood*</p> <p>PXX Specialty Paint Color*</p> <p>C Custom/RAL Color**</p> <p>* Wood "D" selection to be used with Z trim and PM mounting - Refer to Wood Trim Guide</p> <p>** Refer to Finish Guide</p> <p>FINISH GUIDE LINK</p> <p>WOOD TRIM GUIDE</p>	<p>EM Emergency Pack</p> <p>CP Chicago Plenum</p> <p>Controls</p> <p>LR Lutron Wireless RF PowPak</p> <p>ATH Lutron Athena Wireless Node Must be used with E2 driver</p> <p>CA Casambi Wireless BLE to be paired with driver</p>

Ceiling Cutouts and Dimensions

Round Flangeless Housing

Plaster Mount (P/AP)

CR4WW-RF-Z-P/AP-

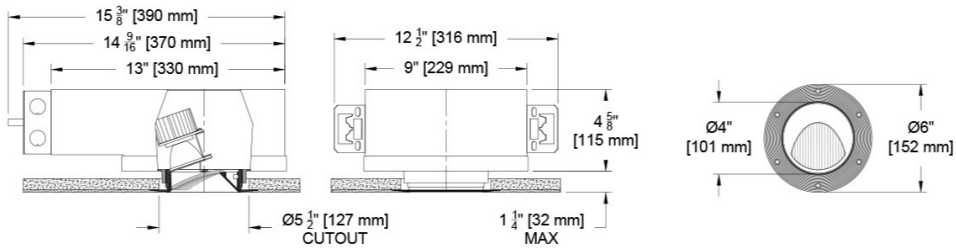

Hanger Bar Detail

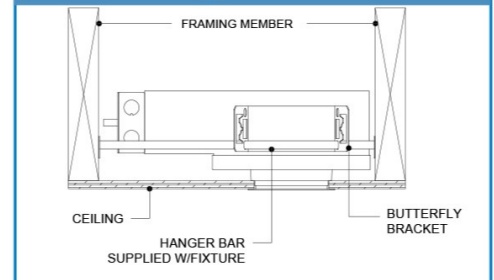

Round Flanged Housing

Universal Mount (U/AU)

CR4WW-RF-F-U/AU-

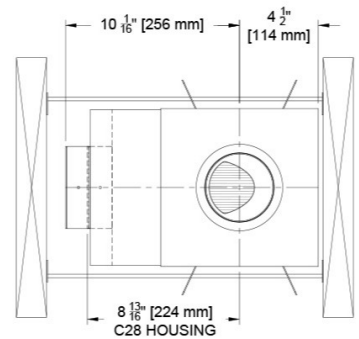
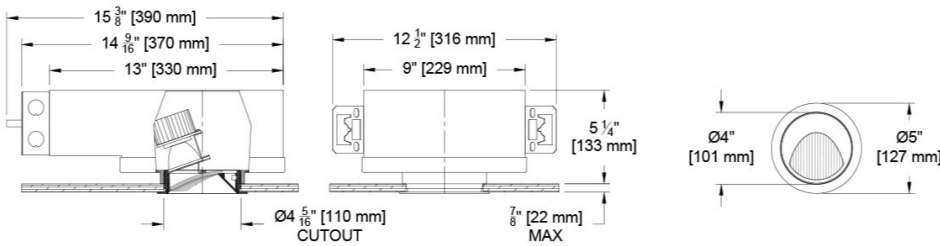

Round Flangeless Housing

Panel Mount (PM)

CR4WW-RF-Z-PM-

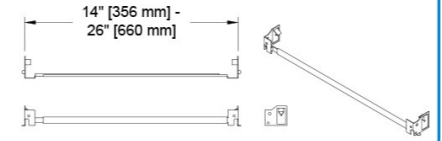
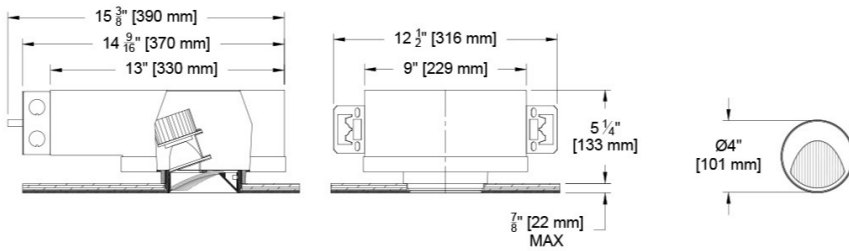

Round Housing for

(P) (U) (PM) C28 Only*

CR4WW-RF-F/Z-P/U/PM-C28-

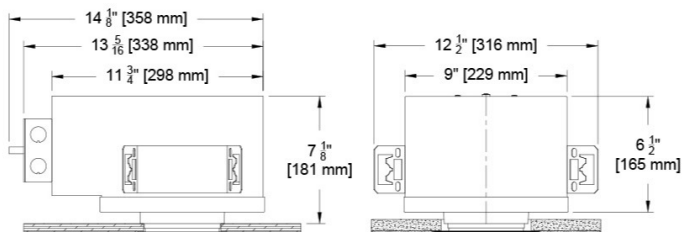

Panel Mount Detail

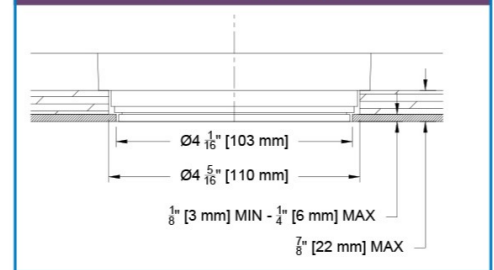

Ceiling Cutouts and Dimensions

Round Flangeless Housing

Airtight Shallow Plaster (ASP)

CR4WW-RF-DR-Z-ASP-

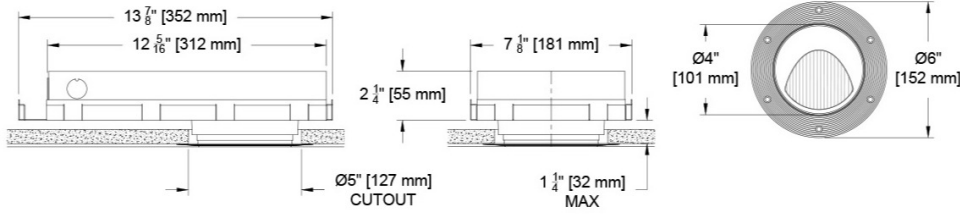

Hanger Bar Detail

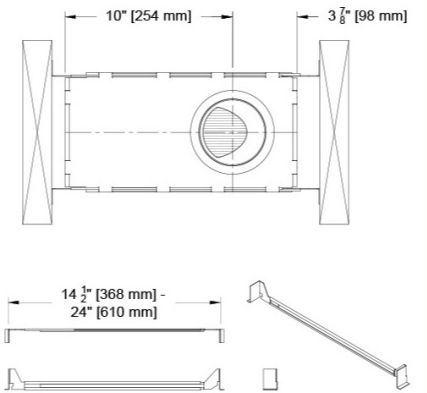
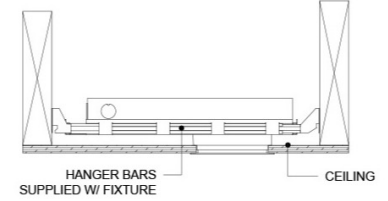

Round Flanged Housing

Airtight Shallow Universal (ASU)

CR4WW-RF-DR-F-ASU-

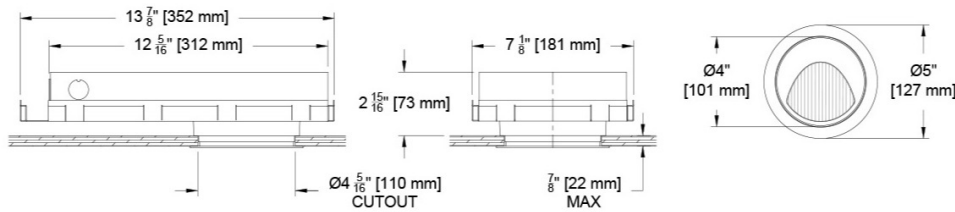

Round Flangeless Housing

Airtight Shallow Panel (ASPM)

CR4WW-RF-Z-ASPM-

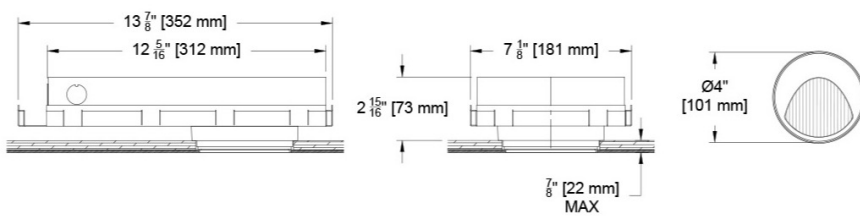

Panel Mount Detail

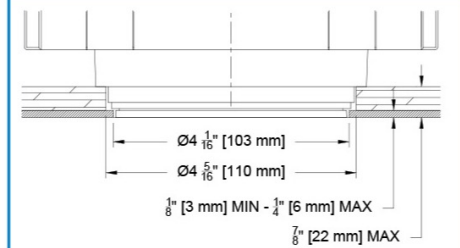

Photometric Table All data is based from goniometer measurements of production representative product. All lumen values can vary +/- 10% from LED manufacturer rated flux range. Measurements at 3000 CCT.

Round Wall Wash (CR4WW-RF)			
Source	System watts (W)	Delivered Lumens (lm)	Lumens/ Watt
Citizen C14	14	833	60
Citizen C20	20	1056	53
Citizen C28*	31	1616	53
Ambient Dim A14	14	578	40

CCT Multiplier	
CCT	Citizen
2700	0.95
3000	1.00
3500	1.02
4000	1.03

All data based on 3000k. See Multipliers for other CCT. Ambient Dim based on 3000k at full output. *C28 requires active cooling and cannot be used with IC housing or Chicago Plenum

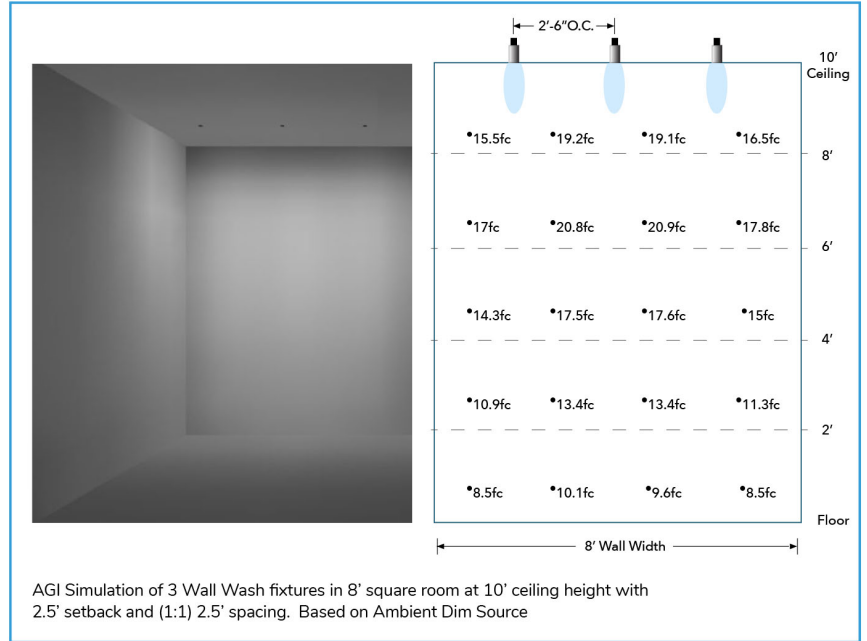

Color Data

All data is based from goniometer measurements of production representative product. All values can vary +/- 10% from LED manufacturer rated data range. Measurements at 3000 CCT.

Citizen Sources - C14, C20 and C28

- <2 MacAdam Ellipse (<2 SDCM)
- 90+ CRI and RF
- 60+R9, Hue Bin 1

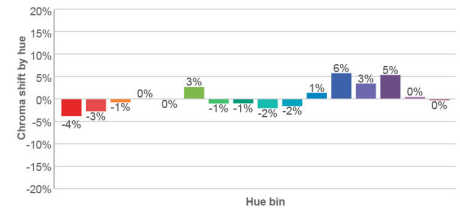
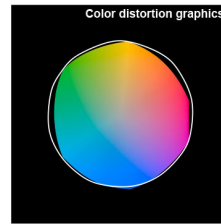
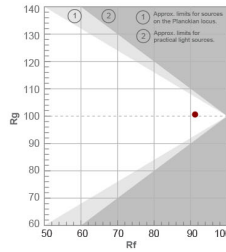
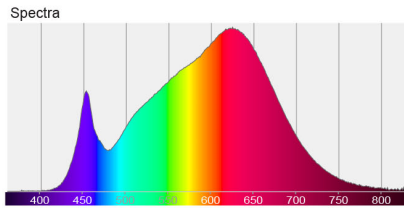
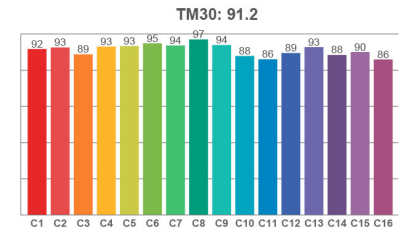
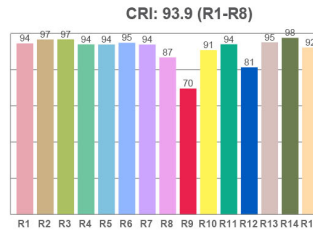
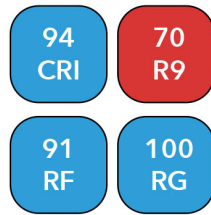

Ambient Dim - 3000k to 1900k

- <3 MacAdam Ellipse (<3 SDCM)
- 95+ CRI and RF
- 90+R9, Hue Bin 1
- Follows Black Body Locus through dimming range

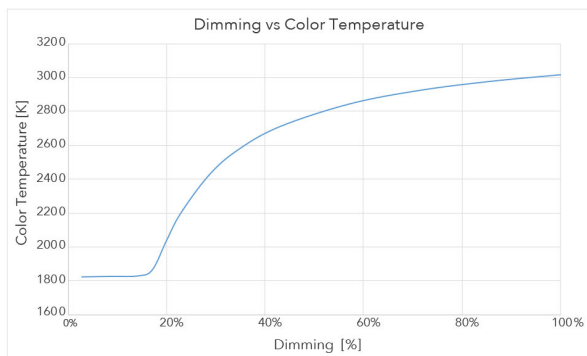

3000 CCT Full Output

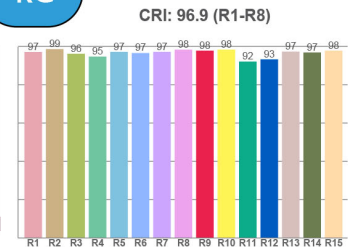
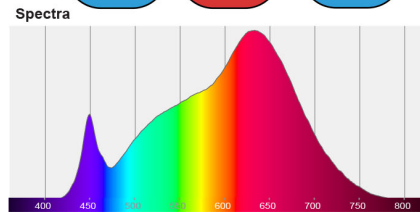

1850 CCT 5% Output

